

MSコネクタ
D/MS3102A22-14P

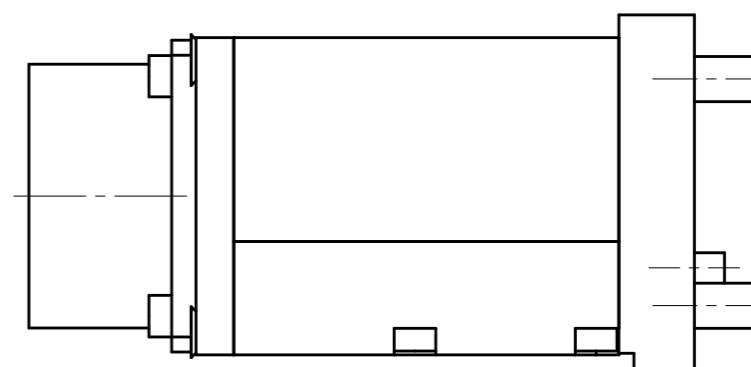

取付可能モデル及び面
QC-150C:Z面

MODEL CODE	M19Z-M	TITLE	マスタコンタクトブロック
SCALE	1/1	SIZE	A3
		13A×19本 (MSコネクタ)	
BL AUTOTEC. LTD.			DATE 2015. 7. 24

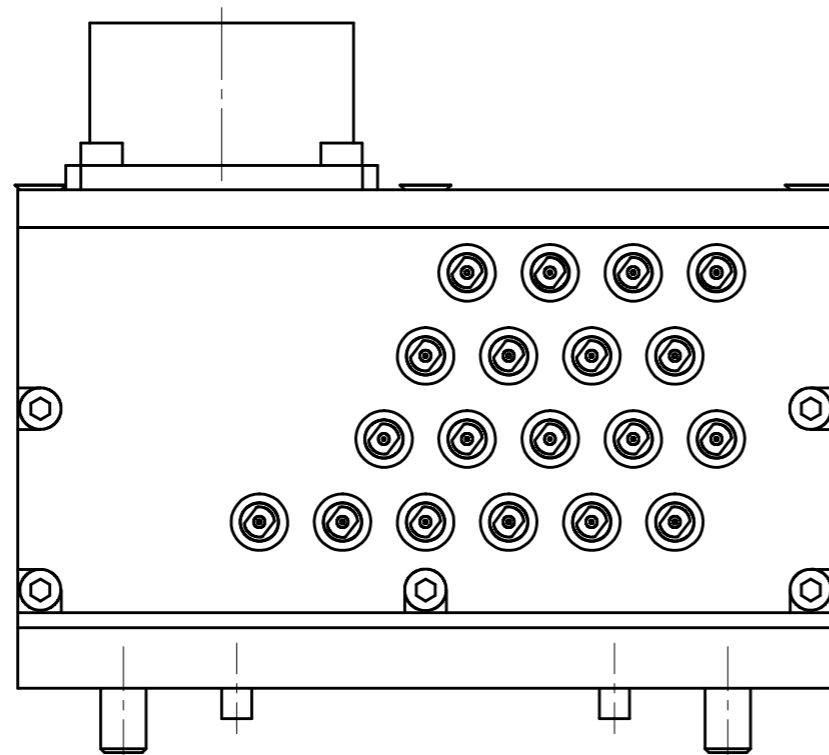
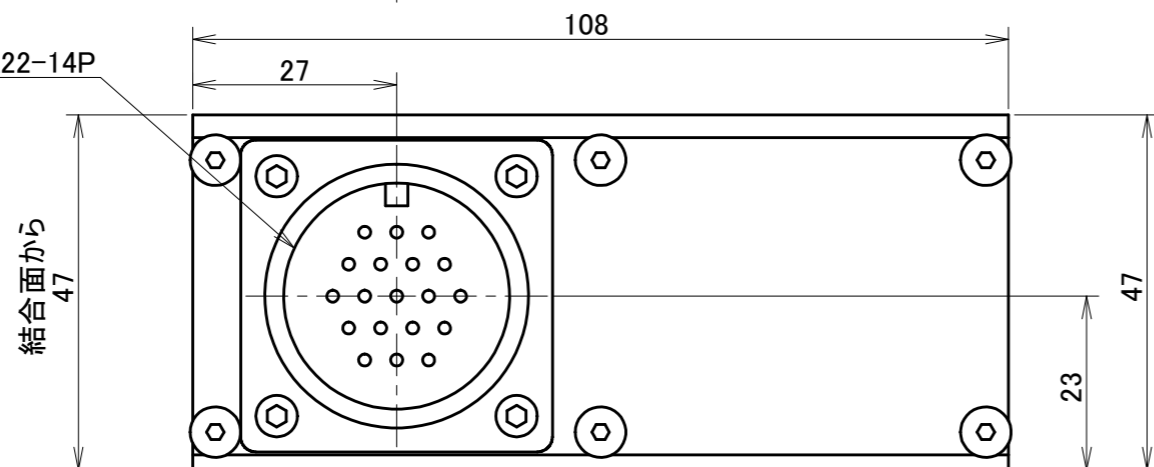
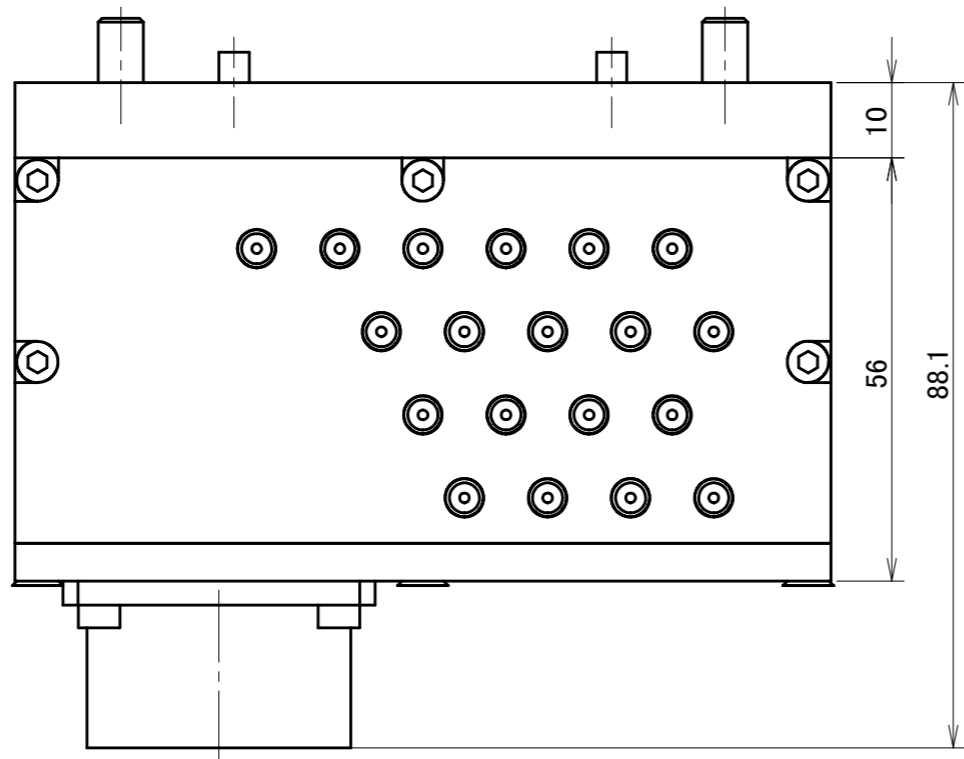

MSコネクタ
D/MS3102A22-14S

結合面から
26.5

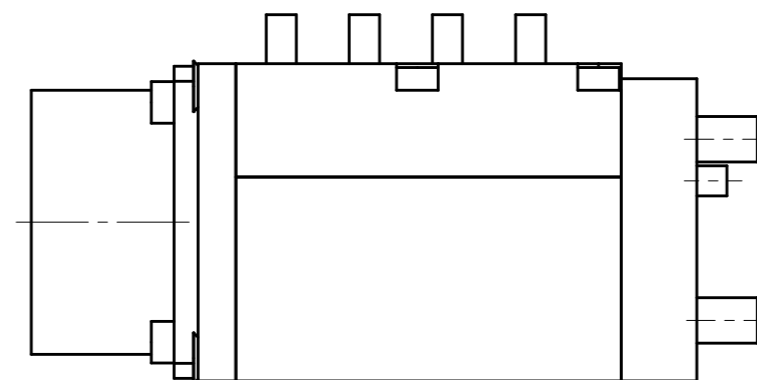
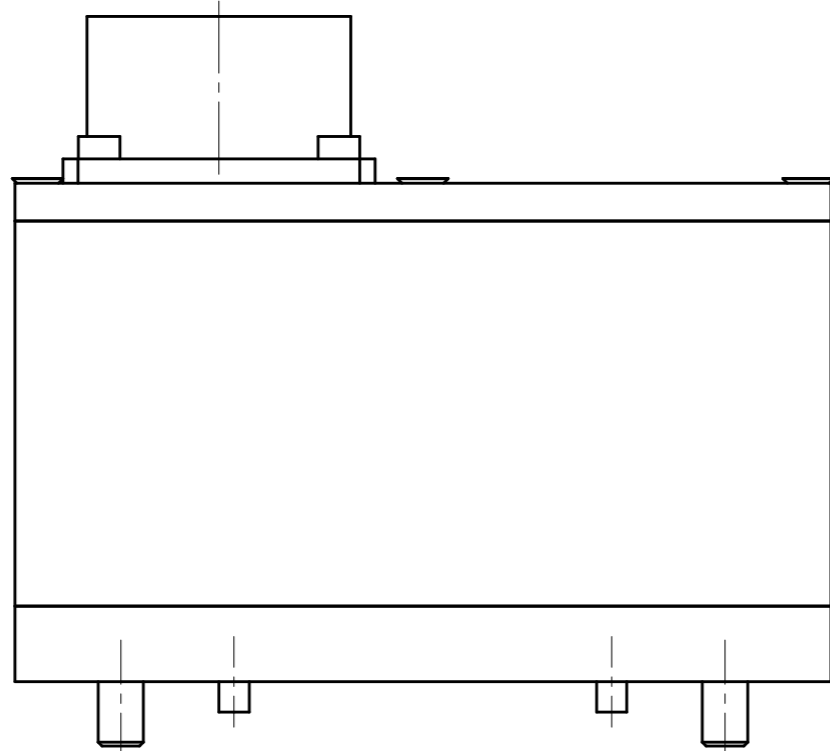
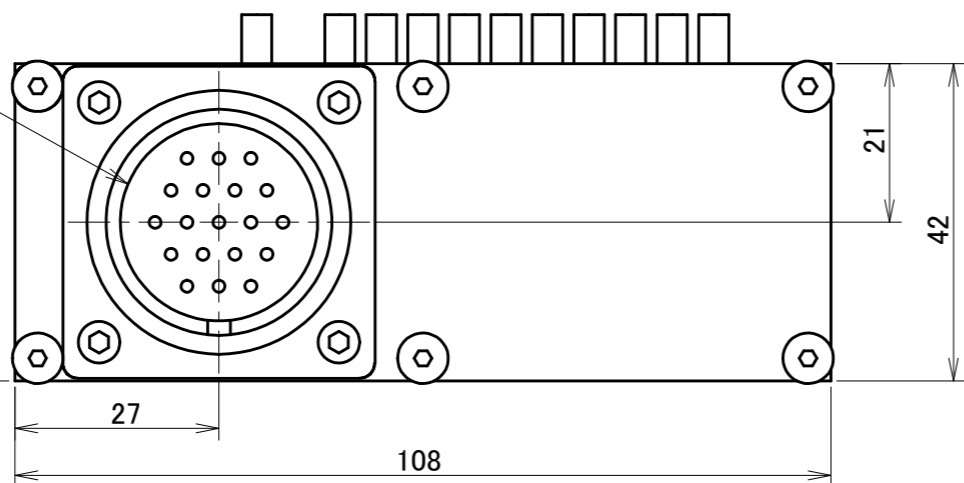

取付可能モデル及び面
QC-150C:Z面

MODEL CODE	M19Z-T	TITLE	ツールコンタクトブロック
SCALE	1/1	SIZE	A3
		13A × 19本 (MSコネクタ)	
DATE			2015. 7. 24
BL AUTOTEC. LTD.			